

Digital temperature transmitter with HART® protocol

Model T32.1S, head mounting version

Model T32.3S, rail mounting version

WIKA data sheet TE 32.04



Applications

- Process industry
- Machine building and plant construction

Special features

- TÜV certified SIL version for protective equipment developed per IEC 61508 (option)
- Configurable with almost all soft- and hardware tools
- Universal for the connection of 1 or 2 sensors
 - Resistance thermometer, resistance sensor
 - Thermocouple, mV sensor
 - Potentiometer
- Signalling in accordance with NAMUR NE43, sensor-break detection in accordance with NE89, EMC in accordance with NE21
- Isolation voltage AC 1200 V between sensor/current loop



Fig. left: Digital temperature transmitter model T32.1S
Fig. right: Digital temperature transmitter model T32.3S

Description

These temperature transmitters are designed for universal use in the process industry. They offer high accuracy, galvanic isolation and excellent protection against electromagnetic influences (EMI). Via HART® protocol, the T32 temperature transmitters are configurable (interoperable) with a variety of open configuration tools. In addition to the different sensor types, e.g. sensors in accordance with DIN EN 60751, JIS C1606, DIN 43760, IEC 60584 or DIN 43710, customer-specific sensor characteristics can also be defined, through the input of value pairs (user-defined linearisation).

Through the configuration of a sensor with redundancy (dual sensor), on a sensor failure it will automatically change over to the working sensor.

Furthermore there is the possibility to activate Sensor Drift Detection. With this, an error signal occurs when the magnitude of the temperature difference between sensor 1 and sensor 2 exceeds a user-selectable value.

The T32 transmitter also has additional sophisticated supervisory functionality such as monitoring of the sensor wire resistance and sensor-break detection in accordance with NAMUR NE89 as well as monitoring of the measuring range. Moreover, this transmitter has comprehensive cyclic self-monitoring functionality.

The dimensions of the head-mounted transmitter match the Form-B DIN connecting heads with extended mounting space, e.g. WIKA model BSS.

The rail-mounted transmitters can be used for all standard rack systems in accordance with IEC 60715.

The transmitters are delivered with a basic configuration or configured according to customer specifications.

Specifications

Temperature transmitter input						
Resistance sensor	max. configurable measuring range ¹⁾	Standard	α values	Minimum measuring span ¹⁴⁾	Typical measuring deviation ²⁾	Temperature coefficient per °C typical ³⁾
Pt100	-200 ... +850 °C	IEC 60751: 2008	$\alpha = 0.00385$	10 K or 3.8 Ω whichever is greater	$\leq \pm 0.12$ °C ⁵⁾	$\leq \pm 0.0094$ °C ^{6) 7)}
Pt(x) ⁴⁾ 10 ... 1000	-200 ... +850 °C	IEC 60751: 2008	$\alpha = 0.00385$		$\leq \pm 0.12$ °C ⁵⁾	$\leq \pm 0.0094$ °C ^{6) 7)}
JPt100	-200 ... +500 °C	JIS C1606: 1989	$\alpha = 0.003916$		$\leq \pm 0.12$ °C ⁵⁾	$\leq \pm 0.0094$ °C ^{6) 7)}
Ni100	-60 ... +250 °C	DIN 43760: 1987	$\alpha = 0.00618$		$\leq \pm 0.12$ °C ⁵⁾	$\leq \pm 0.0094$ °C ^{6) 7)}
Resistance sensor	0 ... 8,370 Ω			4 Ω	$\leq \pm 1.68$ Ω ⁸⁾	$\leq \pm 0.1584$ Ω ⁸⁾
Potentiometer ⁹⁾	0 ... 100 %			10 %	≤ 0.50 % ¹⁰⁾	$\leq \pm 0.0100$ % ¹⁰⁾
Sensor current at the measurement			max. 0.3 mA (Pt100)			
Connection type			1 sensor 2- /4- /3-wire or 2 sensors 2-wire (for further information, please refer to designation of terminal connections)			
Max. wire resistance			50 Ω each wire, 3-/4-wire			
Thermocouple	max. configurable measuring range ¹⁾	Standard	Minimum measuring span ¹⁴⁾		Typical measuring deviation ²⁾	Temperature coefficient per °C typical ³⁾
Type J (Fe-CuNi)	-210 ... +1,200 °C	IEC 60584-1: 1995	50 K or 2 mV whichever is greater		$\leq \pm 0.91$ °C ¹¹⁾	$\leq \pm 0.0217$ °C ^{7) 11)}
Type K (NiCr-Ni)	-270 ... +1,372 °C	IEC 60584-1: 1995			$\leq \pm 0.98$ °C ¹¹⁾	$\leq \pm 0.0238$ °C ^{7) 11)}
Type L (Fe-CuNi)	-200 ... +900 °C	DIN 43760: 1987			$\leq \pm 0.91$ °C ¹¹⁾	$\leq \pm 0.0203$ °C ^{7) 11)}
Type E (NiCr-Cu)	-270 ... +1,000 °C	IEC 60584-1: 1995			$\leq \pm 0.91$ °C ¹¹⁾	$\leq \pm 0.0224$ °C ^{7) 11)}
Type N (NiCrSi-NiSi)	-270 ... +1,300 °C	IEC 60584-1: 1995			$\leq \pm 1.02$ °C ¹¹⁾	$\leq \pm 0.0238$ °C ^{7) 11)}
Type T (Cu-CuNi)	-270 ... +400 °C	IEC 60584-1: 1995			$\leq \pm 0.92$ °C ¹¹⁾	$\leq \pm 0.0191$ °C ^{7) 11)}
Type U (Cu-CuNi)	-200 ... +600 °C	DIN 43710: 1985			$\leq \pm 0.92$ °C ¹¹⁾	$\leq \pm 0.0191$ °C ^{7) 11)}
Type R (PtRh-Pt)	-50 ... +1,768 °C	IEC 60584-1: 1995	150 K	$\leq \pm 1.66$ °C ¹¹⁾	$\leq \pm 0.0338$ °C ^{7) 11)}	
Type S (PtRh-Pt)	-50 ... +1,768 °C	IEC 60584-1: 1995	150 K	$\leq \pm 1.66$ °C ¹¹⁾	$\leq \pm 0.0338$ °C ^{7) 11)}	
Type B (PtRh-Pt)	0 ... +1,820 °C ¹⁵⁾	IEC 60584-1: 1995	200 K	$\leq \pm 1.73$ °C ¹²⁾	$\leq \pm 0.0500$ °C ^{7) 12)}	
mV sensor	-500 ... +1,800 mV		4 mV	$\leq \pm 0.33$ mV ¹³⁾	$\leq \pm 0.0311$ mV ^{7) 13)}	
Connection type			1 sensor or 2 sensors (for further information, please refer to "designation of terminal connections")			
Max. wire resistance			5 k Ω each wire			
Cold junction compensation, configurable			internal compensation or external with Pt100, with thermostat or off			

1) Other units e. g. °F and K possible

2) Measuring deviation (input + output) at ambient temperature 23 °C \pm 3 K, without influence of lead resistance; example calculation see page 4

3) Temperature coefficient (input + output) per °C

4) x configurable between 10 ... 1,000

5) Based on 3-wire Pt100, Ni100, 150 °C MV

6) Based on 150 °C MV

7) In ambient temperature range -40 ... +85 °C

8) Based on a sensor with max. 5 k Ω

9) R_{total} : 10 ... 100 k Ω

10) Based on a potentiometer value of 50 %

11) Based on 400 °C MV with cold junction compensation error

12) Based on 1000 °C MV with cold junction compensation error

13) Based on measuring range 0 ... 1 V, 400 mV MV

14) The transmitter can be configured below these limits but not recommended due to loss of accuracy.

15) Specification valid only for measuring range between 450 ... 1,820 °C

bold: basic configuration

italic: This sensors are not allowed at option SIL (T32.xS.xxx-S)

MV = Measuring value (temperature measuring values in °C)

User linearisation

Via software, customer-specific sensor characteristics can be stored in the transmitter, so that further sensor types can be used. Number of data points: minimum 2; maximum 30

Monitoring functionality with 2 sensors connected (dual sensors)

Redundancy

In the case of a sensor error (sensor-break, wire resistance too high or outside the measuring range of the sensor) of one of the two sensors, the process value will be the value from the error-free sensor. Once the error is rectified, the process value will again be based on the two sensors, or on sensor 1.

Ageing-control (sensor-drift-monitoring)

An error signal on the output is activated if the value of the temperature difference between sensor 1 and sensor 2 is higher than a set value, which can be selected by the user. This monitoring only generates a signal if two valid sensor values can be determined and the temperature difference is higher than the selected limit value.
(Cannot be selected for the 'Difference' sensor function, since the output signal already indicates the difference value).

Sensor functionality when 2 sensors have been connected (dual sensor)

Sensor 1, sensor 2 redundant:

The 4 ... 20 mA output signal delivers the process value of sensor 1. If sensor 1 fails, the process value of sensor 2 is output (sensor 2 is redundant).

Average

The 4 ... 20 mA output signal delivers the average of the two values from sensor 1 and sensor 2. If one sensor fails, the process value of the working sensor is output.

Minimum value

The 4 ... 20 mA output signal delivers the lower of the two values from sensor 1 and sensor 2. If one sensor fails, the process value of the working sensor is output.

Maximum value

The 4 ... 20 mA output signal delivers the higher of the two values from sensor 1 and sensor 2. If one sensor fails, the process value of the working sensor is output.

Difference *)

The 4 ... 20 mA output signal delivers the difference of the two values from sensor 1 and sensor 2. If one sensor fails, an error signal will be activated.

*) This operating mode is not allowed at option SIL (T32.xS.xxx-S).

Note:

The transmitter can be configured below these limits but not recommended due to loss of accuracy.

Analogue output, output limits, signalling, isolation resistance

Analogue output, configurable	linear to temperature per IEC 60751 , JIS C1606, DIN 43760 (for resistance sensors) or linear to temperature per IEC 584 / DIN 43710 (for thermocouples) 4 ... 20 mA or 20 ... 4 mA, 2-wire design	
Output limits, configurable per NAMUR NE43 customer specific, adjustable option SIL (T32.xS.xxx-S)	lower limit 3.8 mA 3.6 ... 4.0 mA 3.8 ... 4.0 mA	upper limit 20.5 mA 20.0 ... 21.5 mA 20.0 ... 20.5 mA
Current value for signalling, configurable per NAMUR NE43 default value option SIL (T32.xS.xxx-S)	down scale < 3.6 mA (3.5 mA) 3.5 ... 12.0 mA 3.5 ... 3.6 mA	up scale > 21.0 mA (21.5 mA) 12.0 ... 23.0 mA 21.0 ... 23.0 mA
In simulation mode, independent from input signal, simulation value configurable from 3.5 ... 23.0 mA		
Load R_A (without HART®)	$R_A \leq (U_B - 10.5 \text{ V}) / 0.023 \text{ A}$ with R_A in Ω and U_B in V	
Load R_A (with HART®)	$R_A \leq (U_B - 11.5 \text{ V}) / 0.023 \text{ A}$ with R_A in Ω and U_B in V	
Insulation voltage (input to analogue output)	AC 1200 V, (50 Hz / 60 Hz); 1 s	
Insulation specification to DIN EN 60664-1:2003	Overvoltage category III	

Rise time, damping, measuring rate

Rise time t_{90}	approx. 0.8 s
Damping, configurable	off ; configurable between 1 s and 60 s
Turn on time (time to get the first measured value)	max. 15 s
Measuring rate ¹⁾	measured value update approx. 3/s

1) Valid only for single RTD/Thermocouple sensor

Measuring deviation, temperature coefficient, long-term stability

Effect of load	not measurable				
Power supply effect	not measurable				
Warm-up time	after approx. 5 minutes the instrument will function to the specified technical data (accuracy)				
Input	Measuring deviation per DIN EN 60770, 23 °C ± 3 K	Average temperature coefficient (TC) for each 10 K ambient temperature change in the range -40 ... +85 °C 1)	Connection lead effects	Long-term stability 1 year	
Resistance thermometer Pt100/JPt100/ Ni100 2)	-200 °C ≤ MW ≤ 200 °C: ±0.10 K MW > 200 °C: ±(0.1 K + 0.01 % MW-200 K) 3)	±(0.06 K + 0.015 % MW)	4-wire: no effect (0 to 50 Ω each wire) 3-wire: ±0.02 Ω / 10 Ω (0 to 50 Ω each wire)	±60 mΩ or 0.05 % of MV, whichever is greater	
Resistance sensor 5)	≤ 890 Ω: 0.053 Ω 6) or 0.015 % MV 7) ≤ 2140 Ω: 0.128 Ω 6) or 0.015 % MV 7) ≤ 4390 Ω: 0.263 Ω 6) or 0.015 % MV 7) ≤ 8380 Ω: 0.503 Ω 6) or 0.015 % MV 7)	±(0.01 Ω + 0.01 % MV)	2-wire: resistor of the connection leads 4)		
Potentiometer 5)	R _{part} /R _{total} is max. ±0.5 %	±(0.1 % MV)		±20 μV or 0.05 % of MV, whichever is greater	
Thermocouples Type E, J	-150 °C < MV < 0 °C: ±(0.3 K + 0.2 % MV) MV > 0 °C: ±(0.3 K + 0.03 % MV)	Type E: MV > -150 °C: ±(0.1 K + 0.015 % MV) Type J: MV > -150 °C: ±(0.07 K + 0.02 % MV)	6 μV / 1,000 Ω 8)		
Type T, U	-150 °C < MV < 0 °C: ±(0.4 K + 0.2 % MV) MV > 0 °C: ±(0.4 K + 0.01 % MV)	-150 °C < MV < 0 °C: ±(0.07 K + 0.04 % MV) MV > 0 °C: ±(0.07 K + 0.01 % MV)			
Type R, S	50 °C < MV < 400 °C: ±(1.45 K + 0.12 % MV-400 K) 400 °C < MV < 1600 °C: ±(1.45 K + 0.01 % MV-400 K)	Type R: 50 °C < MV < 1,600 °C: ±(0.3 K + 0.01 % MV - 400 K) Type S: 50 °C < MV < 1,600 °C: ±(0.3 K + 0.015 % MV - 400 K)			
Type B	450 °C < MV < 1000 °C: ±(1.7 K + 0.2 % MV - 1,000 K) MV > 1,000 °C: ±1.7 K	450 °C < MV < 1,000 °C: ±(0.4 K + 0.02 % MV - 1,000 K) MV > 1,000 °C: ±(0.4 K + 0.005 % (MV - 1,000 K))			
Type K	-150 °C < MV < 0 °C: ±(0.4 K + 0.2 % MV) 0 °C < MV < 1,300 °C: ±(0.4 K + 0.04 % MV)	-150 °C < MV < 1,300 °C: ±(0.1 K + 0.02 % MV)			
Type L	-150 °C < MV < 0 °C: ±(0.3 K + 0.1 % MV) MV > 0 °C: ±(0.3 K + 0.03 % MV)	-150 °C < MV < 0 °C: ±(0.07 K + 0.02 % MV) MV > 0 °C: ±(0.07 K + 0.015 % MV)			
Type N	-150 °C < MV < 0 °C: ±(0.5 K + 0.2 % MV) MV > 0 °C: ±(0.5 K + 0.03 % MV)	-150 °C < MV < 0 °C: ±(0.1 K + 0.05 % MV) MV > 0 °C: ±(0.1 K + 0.02 % MV)			
mV sensor 5)	≤ 1,160 mV: 10 μV + 0.03 % MV > 1,160 mV: 15 μV + 0.07 % MV	2 μV + 0.02 % MV 100 μV + 0.08 % MV			
Cold junction compensation (CJC) 9)	±0.8 K	±0.1 K			
Output	±0.03 % of measuring span	±0.03 % of measuring span			±0.05 % of span

Total measuring deviation

Addition: input + output per DIN EN 60770, 23 °C ± 3 K

MV = Measuring value (temperature measuring values in °C)

Measuring span = configurable upper limit of measuring range - configurable lower limit of measuring range

1) T32.1S: with the extended ambient temperature (-50 ... -40 °C) the value is doubled

2) For sensor Ptx (x = 10 ... 1,000) applies:

for x ≥ 100: permissible error, as for Pt100

for x < 100: permissible error, as for Pt100 with a factor (100/x)

3) Additional error for resistance thermometers in a 3-wire configuration with zero-balanced cable: 0.05 K

4) The specified resistance value of the sensor wire can be subtracted from the calculated measured sensor resistance.

Dual sensor: configurable for each sensor separately

5) This operating mode is not allowed at option SIL (T32.xS.xxx-S).

6) Double value at 3-wire

7) Greater value applies

8) Within a range of 0 ... 10 kΩ wire resistance

9) Only for thermocouple

Basic configuration:

Input signal: Pt100 in 3-wire connection, measuring range: 0 ... 150 °C

Example calculation

Pt100 / 4-wire / measuring range 0 ... 150 °C / ambient temperature 33 °C

Input Pt100, MV < 200 °C ±0.100 K

Input ±(0.03 % of 150 K) ±0.045 K

TC 10 K - input ±(0.06 K + 0.015 % of 150 K) ±0.083 K

TC 10 K - output ±(0.03 % of 150 K) ±0.045 K

Measuring deviation (typical) ±0.145 K

($\sqrt{\text{input}^2 + \text{output}^2 + \text{TC}_{\text{input}}^2 + \text{TC}_{\text{output}}^2}$)

Measuring deviation (maximum) ±0.273 K

(input + output + TC_{input} + TC_{output})

Thermocouple type K / measuring range 0 ... 400 °C / internal compensation (cold junction) / ambient temperature 23 °C

Input type K, 0 °C < MV < 1,300 °C ±0.56 K

±(0.4 K + 0.04 % of 400 K)

Cold junction ±0.8 K ±0.80 K

Output ±(0.03 % of 400 K) ±0.12 K

Measuring deviation (typical) ±0.98 K

($\sqrt{\text{input}^2 + \text{cold junction}^2 + \text{output}^2}$)

Measuring deviation (maximum) ±1.48 K

(input + cold junction + output)

Monitoring

Test current for sensor monitoring ¹⁾	nom. 20 µA during test cycle, otherwise 0 µA
Monitoring NAMUR NE89 (monitoring of input lead resistance)	
■ Resistance thermometer (Pt100, 4-wire)	$R_{L1} + R_{L4} > 100 \Omega$ with hysteresis 5 Ω $R_{L2} + R_{L3} > 100 \Omega$ with hysteresis 5 Ω
■ Thermocouple	$R_{L1} + R_{L4} + R_{\text{thermocouple}} > 10 \text{ k}\Omega$ with hysteresis 100 Ω
Sensor burnout monitoring	Activated
Self monitoring	active permanently, e.g. RAM/ROM test, logical program operating checks and validity check
Measuring range monitoring	monitoring of the set measuring range for upper/lower deviations
Monitoring of input lead resistance (3-wire)	monitoring for resistance difference between wire 3 and 4; an error will be set, if there is a difference ($> 0,5 \Omega$) between wire 3 and 4

1) Only for thermocouple

Explosion protection, power supply

Model	Approvals	Permissible ambient, storage temperature (per temperature codes and classes)	Safety-related maximum values for Sensor (connections 1 up to 4)	Current loop (connections \pm)	Power supply U_B (DC) ²⁾
T32.xS.000	without	{-50} -40 ... +85 °C	-	-	10.5 ... 42 V
T32.1S.0IS, T32.3S.0IS	EC-type examination certificate: BVS 08 ATEX E 019 X Zones 0, 1: II 1G Ex ia IIC T4/T5/T6 Zones 20, 21: II 1D Ex iaD T120 °C intrinsically safe per directive 94/9/EG (ATEX) Zones 0, 1: II (1G) 2G Ex ia IIC T4/T5/T6 Zones 20, 21: II (1D) 2D Ex iaD T120 °C intrinsically safe per directive 94/9/EG (ATEX)	Gas, category 1 and 2 {-50} -40 ... +85 °C (T4) {-50} -40 ... +75 °C (T5) {-50} -40 ... +60 °C (T6) Dust, category 2 {-50} -40 ... +40 °C ($P_i < 750 \text{ mW}$) {-50} -40 ... +75 °C ($P_i < 650 \text{ mW}$) {-50} -40 ... +100 °C ($P_i < 550 \text{ mW}$)	$U_o = \text{DC } 6.5 \text{ V}$ $I_o = 9.3 \text{ mA}$ $P_o = 15.2 \text{ mW}$ $C_i = 208 \text{ nF}$ $L_i = \text{negligible}$ Gas, category 1 and 2 IIC: $C_o = 24 \mu\text{F}^{3)}$ $L_o = 365 \text{ mH}$ $L_o/R_o = 1.44 \text{ mH}/\Omega$ IIA: $C_o = 1,000 \mu\text{F}^{3)}$ $L_o = 3,288 \text{ mH}$ $L_o/R_o = 11.5 \mu\text{H}/\Omega$ Dust, category 2 IIB iaD: $C_o = 570 \mu\text{F}^{3)}$ $L_o = 1644 \text{ mH}$ $L_o/R_o = 5.75 \mu\text{H}/\Omega$	Gas, category 1 and 2 $U_i = \text{DC } 30 \text{ V}$ $I_i = 130 \text{ mA}$ $P_i = 800 \text{ mW}$ $C_i = 7.8 \text{ nF}$ $L_i = 100 \mu\text{H}$ Dust, category 2 $U_i = \text{DC } 30 \text{ V}$ $I_i = 130 \text{ mA}$ $P_i = 750/650/550 \text{ mW}$ $C_i = 7.8 \text{ nF}$ $L_i = 100 \mu\text{H}$	10.5 ... 30 V
T32.1S.0IS, T32.3S.0IS	CSA approval 09.2095056 Intrinsically safe installation per drawing 11396220 Class I, Zone 0, Ex ia IIC Class I, Zone 0, AEx ia IIC Non-incendive field wiring per drawing 11396220 Class I, division 2, groups A, B, C, D	{-50} -40 ... +80 °C (T4) {-50} -40 ... +75 °C (T5) {-50} -40 ... +60 °C (T6)		$V_{\text{max}} = \text{DC } 30 \text{ V}$ $I_{\text{max}} = 130 \text{ mA}$ $P_i = 800 \text{ mW}$ $C_i = 7.8 \text{ nF}$ $L_i = 100 \mu\text{H}$ DC 30 V	10.5 ... 30 V
T32.1S.0IS, T32.3S.0IS	FM approval 3034620 Intrinsically safe installation per drawing 11396220 Class I, Zone 0, AEx ia IIC Class I, division 1, groups A, B, C, D FM approval AEx ia only Non-incendive field wiring per drawing 11396220 Class I, division 2, groups A, B, C, D Class I, Division 2, IIC	{-50} -40 ... +85 °C (T4) {-50} -40 ... +75 °C (T5) {-50} -40 ... +60 °C (T6)	$V_{oc} = 6.5 \text{ V}$ $I_{sc} = 9.3 \text{ mA}$ $P_{\text{max}} = 15.2 \text{ mW}$ $C_a = 24 \mu\text{F}$ $L_a = 365 \mu\text{H}$	$V_{\text{max}} = 30 \text{ V}$ $I_{\text{max}} = 130 \text{ mA}$ $P_i = 800 \text{ mW}$ $C_i = 7.8 \text{ nF}$ $L_i = 100 \mu\text{H}$	10.5 ... 30 V
T32.1S.0NI, T32.3S.0NI	II 3G Ex nL IIC T4/T5/T6 II 3G Ex nA IIC T4/T5/T6 II 3G Ex ic IIC T4/T5/T6	{-50} -40 ... +85 °C (T4) {-50} -40 ... +75 °C (T5) {-50} -40 ... +60 °C (T6)	$U_o = \text{DC } 3.1 \text{ V}$ $I_o = 0.26 \text{ mA}$ $C_i = 208 \text{ nF}$ $L_i = \text{negligible}$ $C_o \leq 1,000 \mu\text{F}$ $L_o \leq 1,000 \text{ mH}$ ratio L_o/R_o (for ignition protection type ic) $L_o/R_o \leq 9 \text{ mH}/\Omega$ (for IIC) $L_o/R_o \leq 39 \text{ mH}/\Omega$ (for IIB) $L_o/R_o \leq 78 \text{ mH}/\Omega$ (for IIA)	$U_i = 40 \text{ V}$ $I_i = 23 \text{ mA}^*)$ $P_i = 1 \text{ W}$ $C_i = 7.8 \text{ nF}$ $L_i = 100 \mu\text{H}$	10.5 ... 40 V

2) Power supply input protected against reverse polarity; Load $R_A \leq (U_B - 10.5 \text{ V}) / 0.023 \text{ A}$ with R_A in Ω and U_B in V (without HART®)

On switching on, an increase in the power supply of 2 V/s is needed; otherwise the temperature transmitter will remain in a safe condition at 3.5 mA.

3) C_i already considered

{ } Items in curved brackets are options for additional price, not for rail mounting version T32.3S

*) The maximum operating current is limited by the T32. The maximum output current of the associated energy-limited apparatus does not have to be $\leq 23 \text{ mA}$.

Ambient conditions

Permissible ambient temperature range	{-50} -40 ... +85 °C
Climate class per IEC 654-1: 1993	Cx (-40 ... +85 °C, 5 ... 95 % relative air humidity)
Maximum permissible humidity	
■ Model T32.1S per IEC 60068-2-38: 1974	Test max. temperature variation 65 °C and -10 °C, relative humidity 93 % ±3 %
■ Model T32.3S per IEC 60068-2-30: 2005	Test max. temperature 55 °C, relative humidity 95 %
Vibration per IEC 60068-2-6: 2007	Test Fc: 10 ... 2000 Hz; 10 g, Amplitude 0.75 mm
Shock per IEC 68-2-27: 1987	Test Ea: Acceleration Type I 30 g and Type II 100 g
Salt mist per IEC 60068-2-52	Severity level 1
Freefall in accordance with IEC 60721-3-2: 1997	Drop height 1,500 mm
Electromagnetic compatibility (EMC)	EMC directive 2004/108/EC, DIN EN 61326 emission (Group 1, Class B) and immunity (industrial application), as well as per NAMUR NE21

{ } Items in curved brackets are options for additional price, not for rail mounting version T32.3S

Case

Transmitter model	Material	Weight	Ingress protection ¹⁾	Terminal connections (screws captive)
T32.1S head mounting version	Plastic PBT, glass fibre reinforced	0.07 kg	IP 00 Electronics completely potted	Cross-section head and rail min. 0.14 mm ² Wire cross-section max. 1.5 mm ²
T32.3S rail mounting version	Plastic	0.2 kg	IP 20	Wire cross-section max. 2.5 mm ²

1) Ingress protection per IEC 529 / DIN EN 60529

Options

Models T32.1R, T32.3R

Higher measuring rate	Measured value update approx. 10/s
Limited accuracy	Multiply the accuracy limit values for the model T32.xS by factor 2
Limited sensor diagnostics	Limited self-monitoring function
Sensor input	Only for thermocouples
SIL certification	Without
External cold junction	Without
Dual sensor function	Without

Communication HART® protocol rev. 5 incl. burst mode, Multidrop

Interoperability (i.e. compatibility between components from different manufacturers) is imperative with HART® devices. The T32 transmitter is compatible with almost every open software and hardware tool; among other things with:

1. User-friendly WIKA configuration software, free-of-charge download via www.wika.de
2. HART® communicator HC275, FC375, FC475, MFC4150:
T32 device description (device object file) is integrated and upgradable with old HC275 versions
3. Asset Management Systems
 - 3.1 AMS: T32_DD completely integrated and upgradable with old versions
 - 3.2 Simatic PDM: T32_EDD completely integrated from version 5.1, upgradable with version 5.0.2
 - 3.3 Smart Vision: DTM upgradable per FDT 1.2 standard from SV version 4
 - 3.4 PACTware (see accessories): DTM completely integrated and upgradable as well as all supporting applications with FDT 1.2 interface
 - 3.5 Fieldmate: DTM upgradable

Attention:

For direct communication via the serial interface of a PC/notebook, a HART® modem is needed (see "Accessories"). As a general rule, parameters which are defined in the scope of the universal HART® commands (e.g. the measuring range) can, in principle, be edited with all HART® configuration tools.

Load diagram

The permissible load depends on the loop supply voltage.

Load $R_A \leq (U_B - 10.5 \text{ V}) / 0.023 \text{ A}$ with R_A in Ω and U_B in V (without HART®)

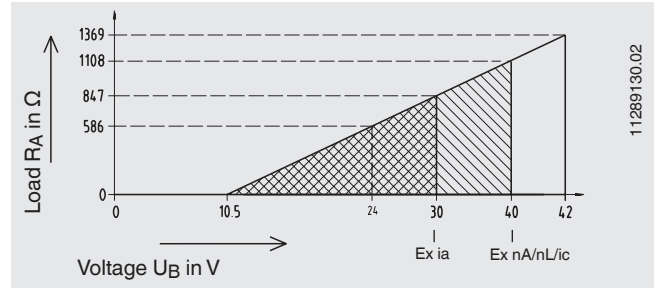

Designation of terminal connectors

Input resistance sensor/thermocouple

Thermocouple CJC with external Pt100	Resistance thermometer/ resistance sensor in 4-wire 3-wire 2-wire	Potentiometer	Dual thermocouple Dual mV sensor	Dual resistance thermometer/ dual resistance sensor in 2+2-wire

Analogue output
4 ... 20 mA - loop

Identical dual sensors are supported for all sensor models, i. e. dual sensor combinations as for example Pt100/Pt100 or thermocouple type K/type K are possible.
A further rule is that both sensor values have the same unit and the same sensor range.

For head mounting and rail mounting case, connection clamps for the HART® modem are available.

Dimensions in mm

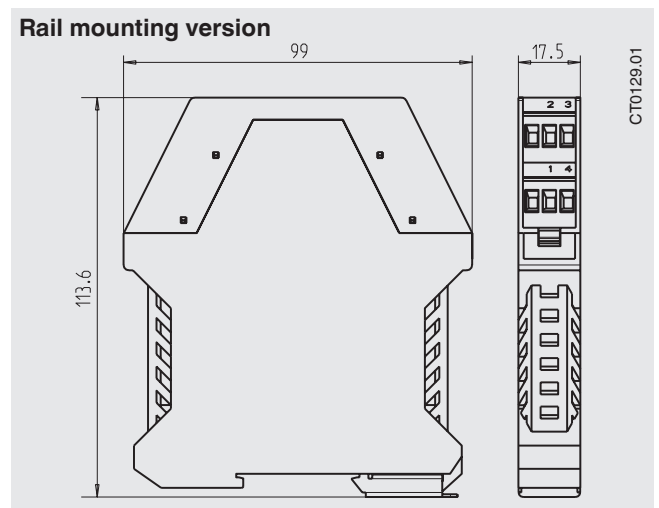
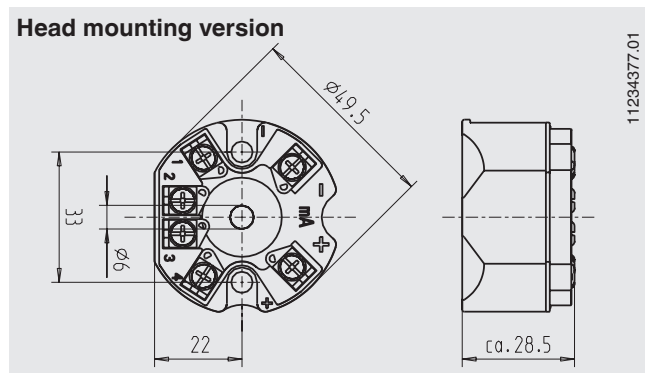

Typical connection for hazardous areas

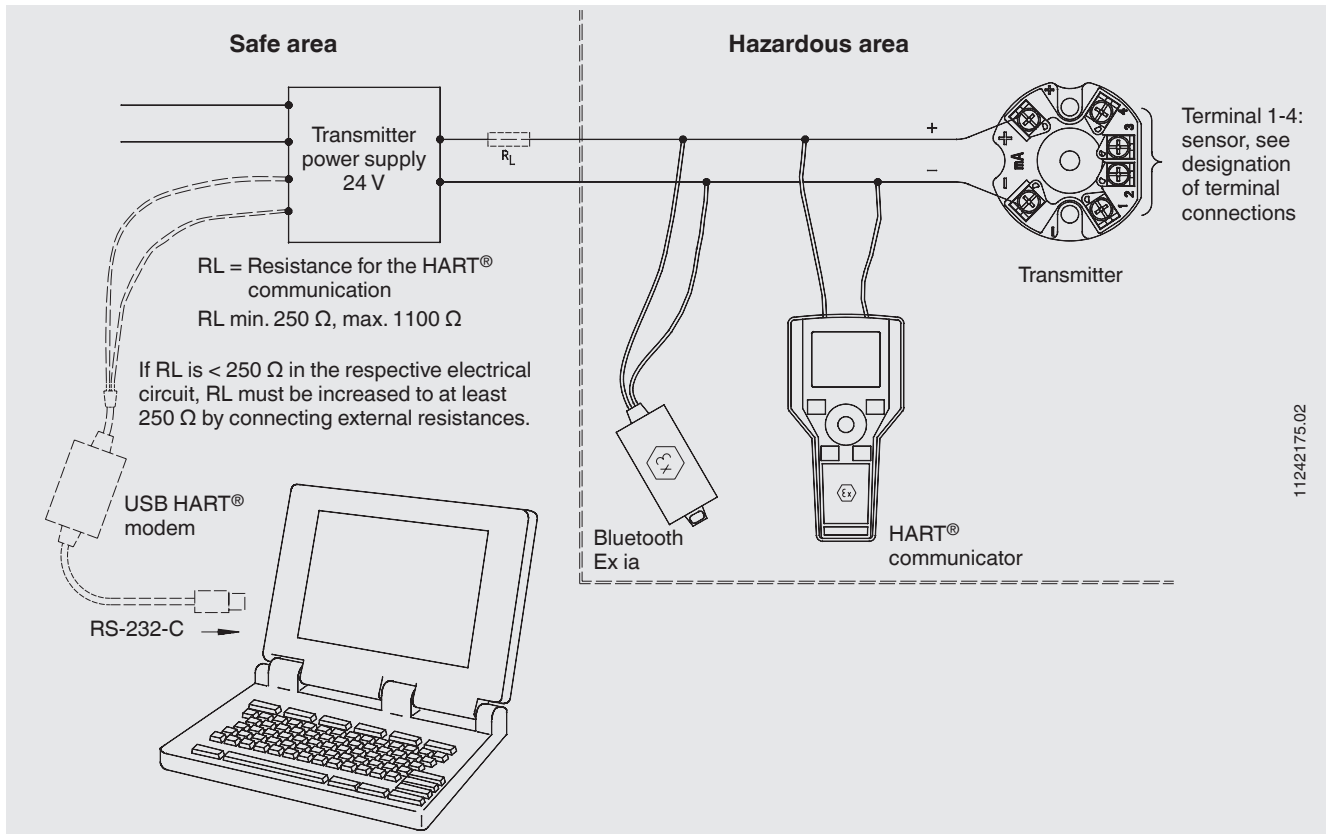



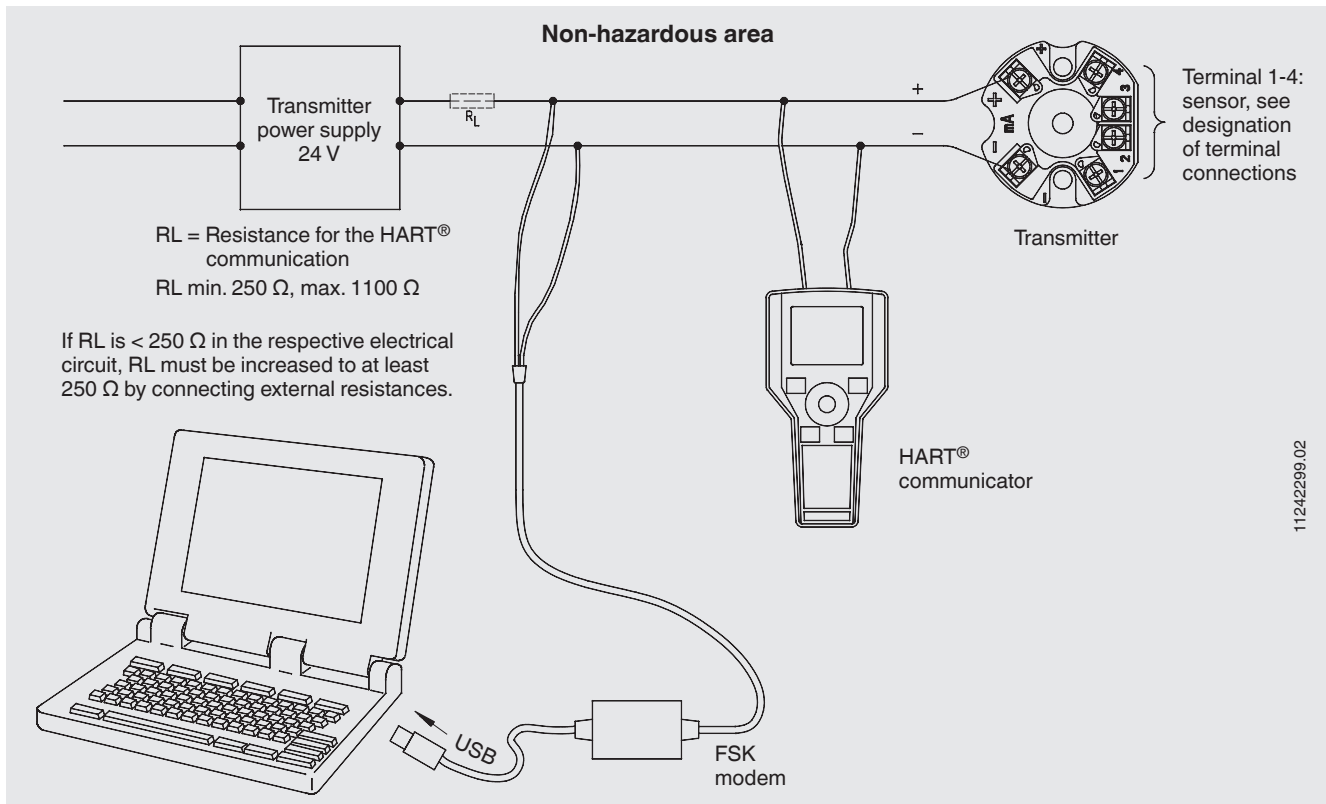

Typical connection for non-hazardous areas



Accessories

WIKA configuration software: free download from www.wika.com



DIH50-F with field housing, adapter

Model	Design	Special features	Dimensions	Order No.
DIH50, DIH52 with field housing 	Aluminium	DIH50 digital indicator without separate auxiliary power supply, automatically rescales to the new measuring range and its units via supervision of the HART® communication, 5-digit LC display, 20 segment bargraph, display rotatable in 10° steps, with explosion protection II 1G EEx ia IIC; see data sheet AC 80.10	150 x 127 x 138 mm	on request
Adapter 	Plastic / stainless steel	suitable for TS 35 per DIN EN 60715 (DIN EN 50022) or TS 32 per DIN EN 50035	60 x 20 x 41.6 mm	3593789
Adapter 	Steel tin galvanized	suitable for TS 35 per DIN EN 60715 (DIN EN 50022)	49 x 8 x 14 mm	3619851
Magnetic quick connector magWIK 		<ul style="list-style-type: none"> ■ Replacement for crocodile clips and HART® terminals ■ Fast, safe and tight electrical connection ■ For all configuration and calibration processes 		11604328

HART® modem

Model	Description	Order No.
Model 010031 	USB-interface, specifically designed for use with modern notebooks	11025166
Model 010001	RS-232 interface	7957522
Model 010041	Bluetooth-interface [EEx ia] IIC	11364254

HART® communicator

Model	Description	Order No.
FC475HP1EKLUGMT 	HART® protocol, Li-Ion battery, power supply AC 90 ... 240 V, without EASY UPGRADE; ATEX, FM and CSA (intrinsically safe)	on request
FC475FP1EKLUGMT	HART® protocol, FOUNDATION™ Fieldbus, Li-Ion battery, power supply AC 90 ... 240 V, with EASY UPGRADE; ATEX, FM and CSA (intrinsically safe)	on request
MFC4150 	HART® protocol, universal power supply, cable set with 250 Ω resistance, with DOF upgrade, with Ex-protection 	11405333

DTM collection, incl. PACTware

Model	Description	Order No.
DTM collection 	incl. PACTware, contains DTMs for WIKA field devices	12513636

Ordering information

Model / Explosion protection / SIL specifications / Configuration / Permissible ambient temperature / Certificates / Options

© 2008 WIKA Alexander Wiegand SE & Co. KG, all rights reserved.
The specifications given in this document represent the state of engineering at the time of publishing.
We reserve the right to make modifications to the specifications and materials.



WIKAI Alexander Wiegand SE & Co. KG
Alexander-Wiegand-Straße 30
63911 Klingenberg/Germany
Tel. (+49) 9372/132-0
Fax (+49) 9372/132-406
E-mail info@wika.de
www.wika.de